

exo387CU3TR

EXO Tracer



The EXO Tracer is an industrial camera with a fully functional lens control (focus, zoom, aperture). Lens mount is a Micro Four Thirds (MFT) mount. The excellent thermal concept of the EXO qualifies for a operating temperature of up to 60°C.

The MFT beam geometry on the sensor side of the lens works in perfect harmony to the high sensitive Sony IMX sensors. A nearly perfect flatfield is the compelling result. Together with up to 72dB dynamic range and up to 20 MP resolution, the Tracer delivers excellent image quality.

Lens control and integrated strobe controller are integrated into the camera's GenCam 3.0 tree as properties. Any GenCam-driven software is immediately able to use lens control and strobe controller without additional drivers.

Technical Highlights

Rich set of features

- > Full control of lens (focus, zoom, aperture)
- > Global shutter
- > Monochrome and color versions (Bayer Pattern)
- > Various trigger (int./ext./free running) and exposure modes
- > Logic-Trigger functions (PLC)
- > Adjustable gain, auto gain and auto- exposure
- > Various binning modes
- > Area of interest modes (AOI)
- > White balance for color versions
- > Micro Four Thirds lens adapter
- > 8/12 Bit video data stream (14 Bit ADC)
- > 256 MB burst mode frame store
- > 4 x Power Output (PWM)
- > Programmable sequencer für shutter and LED illumination
- > SDK for Windows (32/64 Bit) und Linux available
- > GenCam 3.0 standard compliant
- > Integrated multichannel strobe controller

EXO Series

exo387CU3TR

Resolution	5456 x 3076 px
Frame rate (max.)	22 fps
Chroma	color
Interface	USB3 Vision
Sensor	
Sensor	IMX387LQA
Manufacturer	Sony
Sensor type	Area CMOS
Shutter type	global shutter
Sensor size (h x v)	18.82 x 10.61 mm
Optical diagonal	21.61 mm
Sensor format	21.7mm (4/3)
Pixel size (h x v)	3.45 x 3.45 μ m
Camera	
Exposure modes	MANUAL;AUTO;EXTERNAL
Trigger modes	INTERNAL;SOFTWARE;EXTERNAL
Exposure time (min)	29 μ s
Exposure time (max)	1 sec (external ∞)
Pixel format / max	bayer8, bayer12packed / 12 bit
Gain modes / max	manual, auto / 48 dB
Internal memory	256 MB SDRAM, 32 MB Flash
Feature Set	
Manual white balance	yes
Automatic white balance	yes
AOI	yes
LUT	yes
Offset	yes
Binning	yes
Image flip	yes
Sequencer	yes
Housing	
Lens mount	MFT
Dimensions (w x h x d)	58 x 58 x 50 mm
Weight	320 g
Operating temperature (housing)	-10 to 65 °C
Ambient humidity	10 to 90 % (non-condensing)
Protection class	IP40
I/O-Interfaces	
Input up to 24V	2 x
Input OPTO	1 x
Output open drain	4 x
I/O RS-232	1 x
Power supply	10 to 25 V (DC)
Power consumption	8 W (dep. on operating mode)

Dimensions [mm]

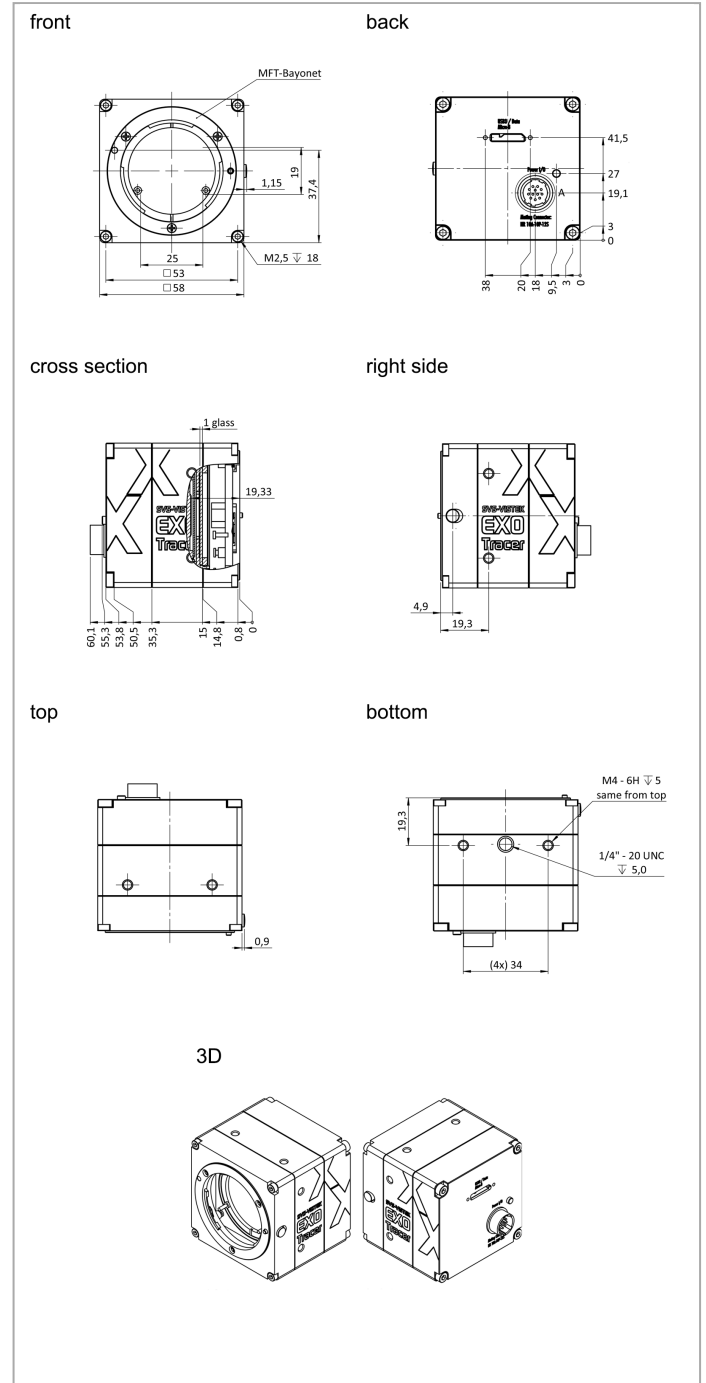

Pinout Mating Connector

Hirose 12 Pin	1	2	3	4	5	6	7	8	9	10	11	12
	VIN -	VIN +	IN 4	OUT 4	IN 1	IN 2	OUT 1	OUT 2	IN 3 +	IN 3 -	OUT 3	OUT 0
	(GND)	(10V to 25V DC)	(RXD RS232)	(TXD RS232)	(0-24V)	(0-24V)	(open drain)	(open drain)	(opto In+)	(opto In-)	(open drain)	(open drain)

Spectral Response *

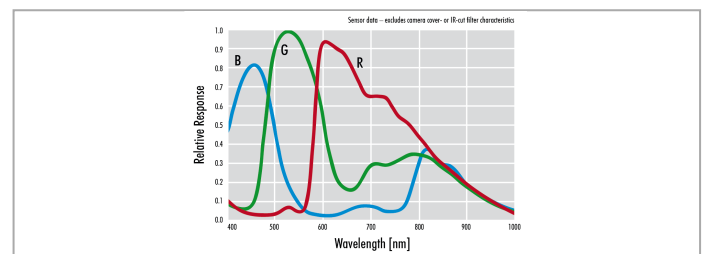

* Sensor data - excludes camera cover- or IR-cut filter characteristics