

exo304MU3

EXO USB3 Vision



The SVCam EXO is one of the most flexible and scalable cameras for the industrial market segment. The USB3 Vision interface is easy to integrate in your system, with a data rate up to effective 360 MB/sec. The time to market for applications is shortened, saving cost even further. Power the camera via the interface and reduce cable complexity. EXO provides Plug-and-play capability for the whole range of 2.3 to 12 MP resolutions.

Technical Highlights

- > Up to 360 MB/s effective transfer rate
- > Leverages existing infrastructure for cables and connectors
- > Powers camera with up to 4.5 W
- > GenICam compliant
- > Cost effective / Easy implementation and interfacing

EXO Series

exo304MU3

Resolution	4096 x 3000 px
Frame rate (max.)	23 fps
Chroma	mono
Interface	USB3 Vision
Sensor	
Sensor	IMX304LLR
Manufacturer	Sony
Sensor type	Area CMOS
Shutter type	global shutter
Sensor size (h x v)	14.13 x 10.35 mm
Optical diagonal	17.52 mm
Sensor format	1.1"
Pixel size (h x v)	3.45 x 3.45 μm
Camera	
Exposure modes	MANUAL;AUTO;EXTERNAL
Trigger modes	INTERNAL;SOFTWARE;EXTERNAL
Exposure time (min)	28 μs
Exposure time (max)	1 sec (external ∞)
Pixel format / max	mono8, mono12packed / 12 bit
Gain modes / max	manual, auto / 48 dB
S/N ratio (max)	39.5 dB (dep. on environment)
Dynamic range (max)	72 dB (dep. on environment)
Internal memory	256 MB SDRAM, 32 MB Flash
Feature Set	
AOI	yes
LUT	yes
Offset	yes
Binning	yes
Image flip	yes
Sequencer	yes
Housing	
Lens mount	C-Mount
Dimensions (w x h x d)	50 x 50 x 34.1 mm
Weight	138 g
Operating temperature (housing)	-10 to 60 °C
Ambient humidity	10 to 90 % (non-condensing)
Protection class	IP40
I/O-Interfaces	
Input up to 24V	2 x
Input OPTO	1 x
Output open drain	4 x
I/O RS-232	1 x
Power supply	10 to 25 V (DC)
Power consumption	4.5 W (dep. on operating mode)

Dimensions [mm]

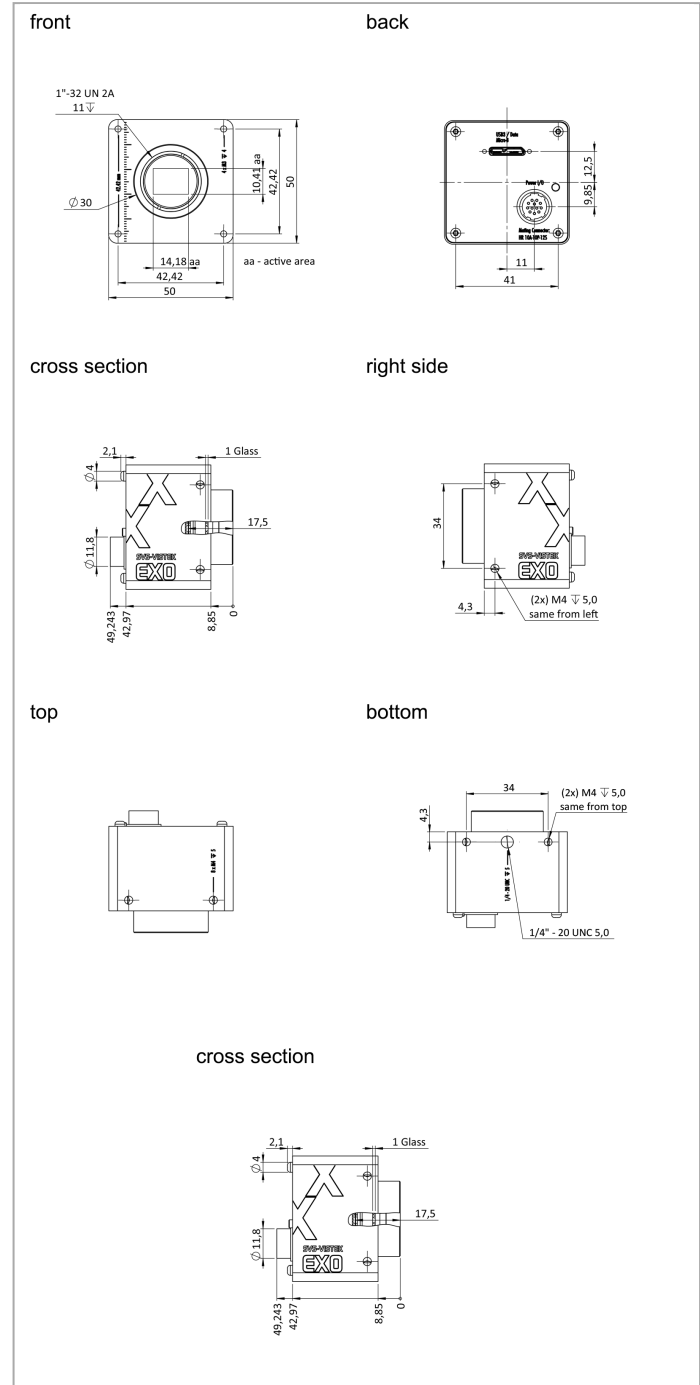

Pinout Mating Connector

	1	VIN - (GND)	7	OUT 1 (open drain)
	2	VIN + (10V to 25V DC)	8	OUT 2 (open drain)
	3	IN 4 (RXD RS232)	9	IN 3 + (opto In +)
	4	OUT 4 (TXD RS232)	10	IN 3 - (opto In -)
	5	IN 1 (0-24V)	11	OUT 3 (open drain)
	6	IN 2 (0-24V)	12	OUT 0 (open drain)

Spectral Response *

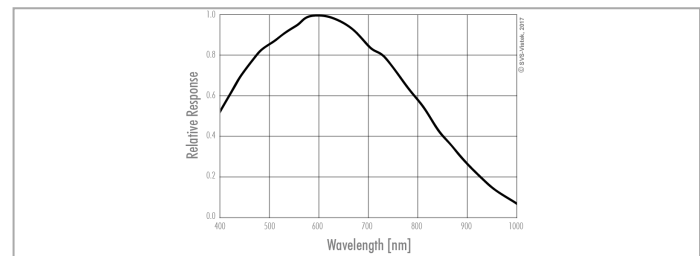

* Sensor data – excludes camera cover- or IR-cut filter characteristics