

eco655MVGE67

ECO IP67 »BlackLine«



Dust tight and protected against water in harmful quantity

Factory automation is dependent on reliable and efficient solutions. For this to happen, the components for machinery, controls and industrial image processing need to work in total harmony. SVS-VISTEK's "BlackLine"-standard makes it easier and more cost efficient to integrate the delicate image processing parts even in harsh environments.

The SVCam-ECO »BlackLine« is equipped with a waterproof housing and a M12 connector concept for industrial field wiring.

The SVCam ECO-series is compelling by virtue of its extremely compact design (38 x 38 x 33 mm) and offers the best value for money. The SVCam-ECO is small, robust, fit for the factory floor, manufactured with precision, safe to connect, offers an LED controller, is PLC ready and reliable.

Technical Highlights

- > IP67 protection class (including lens tube)
- > progressive scan sensor
- > 2 x outputs for direct drive and control of LED lighting
- > up to 120 MB/s data rate
- > GigE Vision and GenICam-Standards compliant
- > Industrial I/O interface for easy Integration
- > large range of Software and Algorithms
- > broadcast-safe

ECO Series

eco655MVG67

Resolution	2448 x 2050 px
Frame rate (max.)	10 fps
Chroma	mono
Interface	GigE Vision
Sensor	
Sensor	ICX655ALA
Manufacturer	Sony
Sensor type	Area CCD
Shutter type	global shutter
Sensor architecture	interline transfer
Readout type	progressive scan
Sensor size (h x v)	8.45 x 7.07 mm
Optical diagonal	11.02 mm
Sensor format	2/3"
Pixel size (h x v)	3.45 x 3.45 μm
Camera	
Exposure modes	MANUAL;AUTO;EXTERNAL
Trigger modes	INTERNAL;SOFTWARE;EXTERNAL
Exposure time (min)	7 μs
Exposure time (max)	60 sec (external ∞)
Pixel format / max	mono8, mono12 / 12 bit
Gain modes / max	manual, auto / 18 dB
Dynamic range (max)	58 dB (dep. on environment)
Internal memory	64 MB SDRAM, 8 MB Flash
Feature Set	
AOI	yes
LUT	yes
Offset	yes
Readout control	yes
Binning	yes
Image flip	yes
Sequencer	yes
Housing	
Lens mount	C-Mount
Dimensions (w x h x d)	42 x 42 x 31.5 mm
Weight	120 g
Ambient temperature	-10 to 45 $^{\circ}\text{C}$
Ambient humidity	10 to 90 % (non-condensing)
Protection class	IP67
I/O-Interfaces	
Input up to 24V	2 x
Output open drain	2 x
I/O RS-232	1 x
I/O RS-422	1 x
Power supply	10 to 25 V (DC)
Power consumption	4.5 W (dep. on operating mode)

Dimensions [mm]

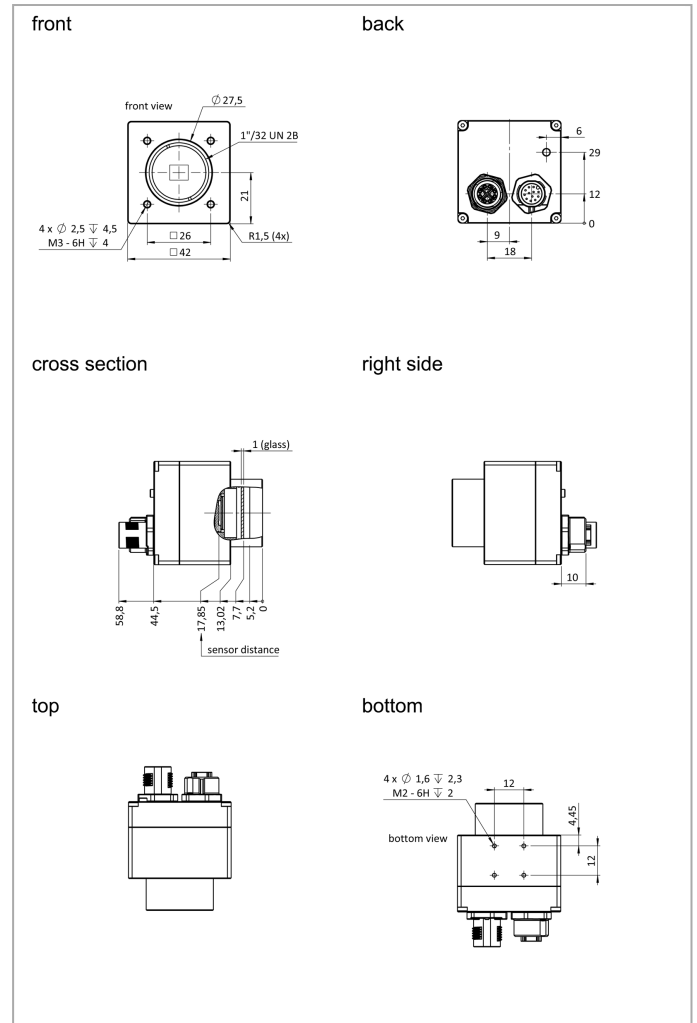

Pinout Mating Connector

Pin	Color Code	Signal
1	brown	V IN+ (10-25V)
2	blue	V IN- (GND)
3	white	RxD (RS232) not available for Pro versions
4	green	TxD (RS232) not available for Pro versions
5	pink	IN 1 (0-24 V)
6	yellow	IN 2 (0-24 V)
7	black	OUT 1 (open Drain max. 24 V, 0.3 A)
8	grey	OUT 2 (open Drain max. 24 V, 0.3 A)
9	red	IN 3+ (RS422)
10	violet	IN 3- (RS422)
11	grey / pink	OUT 3+ (RS422)
12	red / blue	OUT 3- (RS422)
	yellow / green	Shielding

Color Code	Pin RJ45	Pin M12
white / orange	1	1
orange	2	2
white / green	3	3
blue	4	8
white / blue	5	7
green	6	4
white / brown	7	5
brown	8	6

Spectral Response *

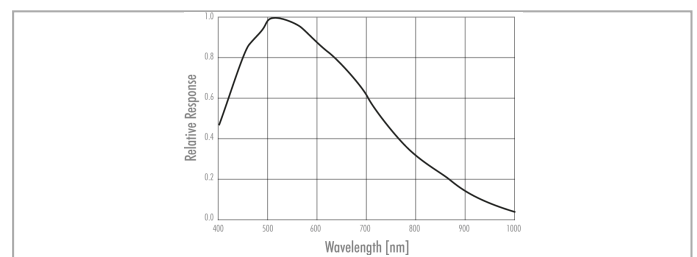

* Sensor data - excludes camera cover- or IR-cut filter characteristics