

eco655MVGE

ECO Standard

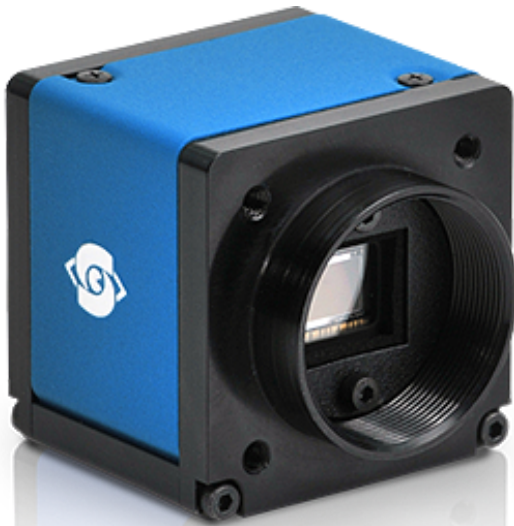

One of the smallest GigE Vision Cameras in the world

The SVScam ECO-series is compelling by virtue of its extremely compact design (38 x 38 x 33 mm) and offers the best value for money. The SVScam-ECO is small, robust, fit for the factory floor, manufactured with precision, safe to connect, offers an LED controller and is PLC ready and reliable.

Technical Highlights

- > progressive scan sensor
- > 2 x outputs for direct drive and control of LED lighting
- > up to 120 MB/s data rate
- > GigE Vision and GenICam-Standards compliant
- > Industrial I/O interface for easy Integration
- > large range of Software and Algorithms
- > broadcast-safe

ECO Series

eco655MVG

Resolution	2448 x 2050 px
Frame rate (max.)	10 fps
Chroma	mono
Interface	GigE Vision
Sensor	
Sensor	ICX655ALA
Manufacturer	Sony
Sensor type	Area CCD
Shutter type	global shutter
Sensor architecture	interline transfer
Readout type	progressive scan
Sensor size (h x v)	8.45 x 7.07 mm
Optical diagonal	11.02 mm
Sensor format	2/3 "
Pixel size (h x v)	3.45 x 3.45 μm

Camera

Exposure modes	MANUAL;AUTO;EXTERNAL
Trigger modes	INTERNAL;SOFTWARE;EXTERNAL
Exposure time (min)	7 μs
Exposure time (max)	60 sec (external ∞)
Pixel format / max	mono8, mono12 / 12 bit
Gain modes / max	manual, auto / 18 dB
Dynamic range (max)	58 dB (dep. on environment)
Internal memory	64 MB SDRAM, 8 MB Flash

Feature Set

AOI	yes
LUT	yes
Offset	yes
Readout control	yes
Binning	yes
Image flip	yes
Sequencer	yes

Housing

Lens mount	CS-Mount
Dimensions (w x h x d)	38 x 38 x 33 mm
Weight	85 g
Ambient temperature	-10 to 45 °C
Ambient humidity	10 to 90 % (non-condensing)
Protection class	IP40

I/O-Interfaces

Input up to 24V	2 x
Output open drain	2 x
I/O RS-232	1 x
I/O RS-422	1 x
Power supply	10 to 25 V (DC)
Power consumption	4.5 W (dep. on operating mode)

Dimensions [mm]

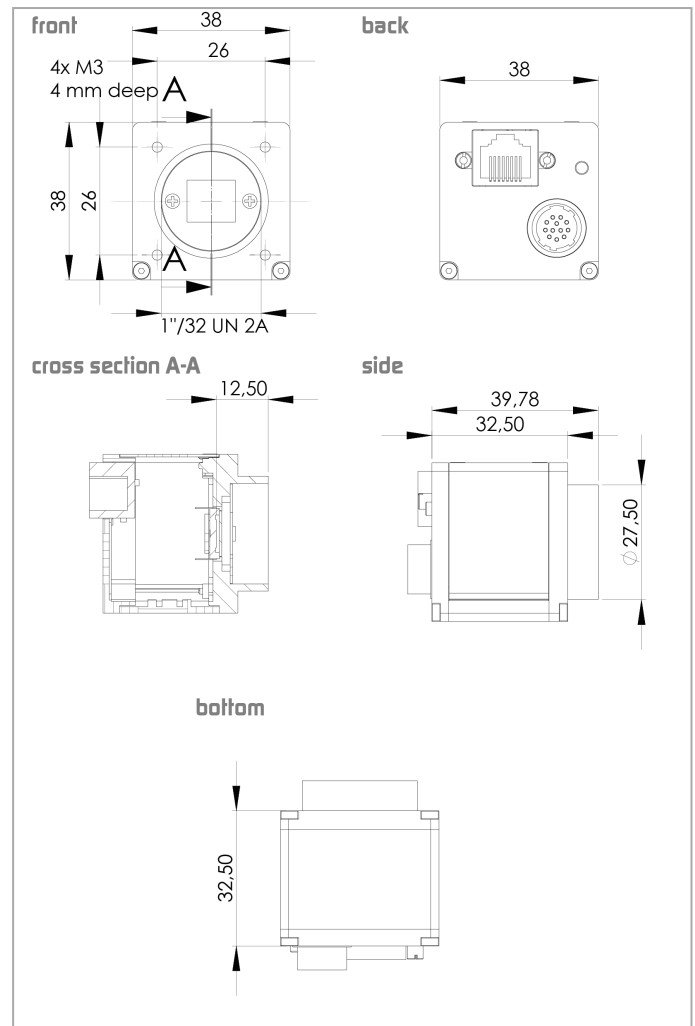

Pinout Mating Connector

Hirose Pinout



Pin	Signal ECO, ECO2, EVO, HR (CL medium, GigE only)	Signal EXO, HR (CL Deca, CXP), SHR	Signal 4 I/O for option ECO
1	V IN- (GND)	V IN- (GND)	V IN- (GND)
2	V IN+ (10 – 25V)	V IN+ (10 – 25V)	V IN+ (10 – 25V)
3	RxD (RS232) not available for PoE versions	IN 4 RxD (RS232)	not connected
4	TxD (RS232) not available for PoE versions	OUT 4 TxD (RS232)	not connected
5	IN 1 (0 – 24 V)	IN 1 (0 – 24 V)	IN 1 (0 – 24 V)
6	IN 2 (0 – 24 V)	IN 2 (0 – 24 V)	IN 2 (0 – 24 V)
7	OUT 1 (open drain)	OUT 1 (open drain)	OUT 1 (open drain)
8	OUT 2 (open drain)	OUT 2 (open drain)	OUT 2 (open drain)
9	IN 3+ (RS422)	IN 3+ (opto IN +)	IN 3 (0 – 24 V)
10	IN 3- (RS422)	IN 3- (opto IN -)	IN 4 (0 – 24 V)
11	OUT 3+ (RS422)	OUT 3 (open drain)	OUT 3 (open drain)
12	OUT 3- (RS422)	OUT 0 (open drain)	OUT 4 (open drain)
	Shielding	Shielding	Shielding

Spectral Response *

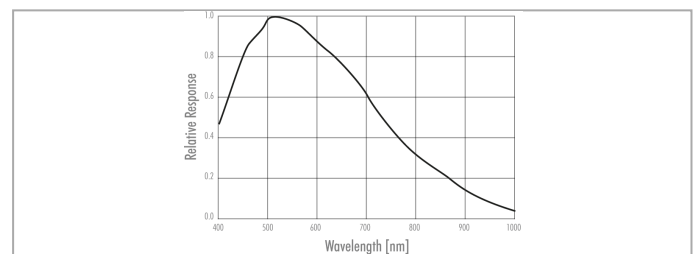

* Sensor data – excludes camera cover- or IR-cut filter characteristics